

MF5

Metal and Conductive Detector

Operations Manual

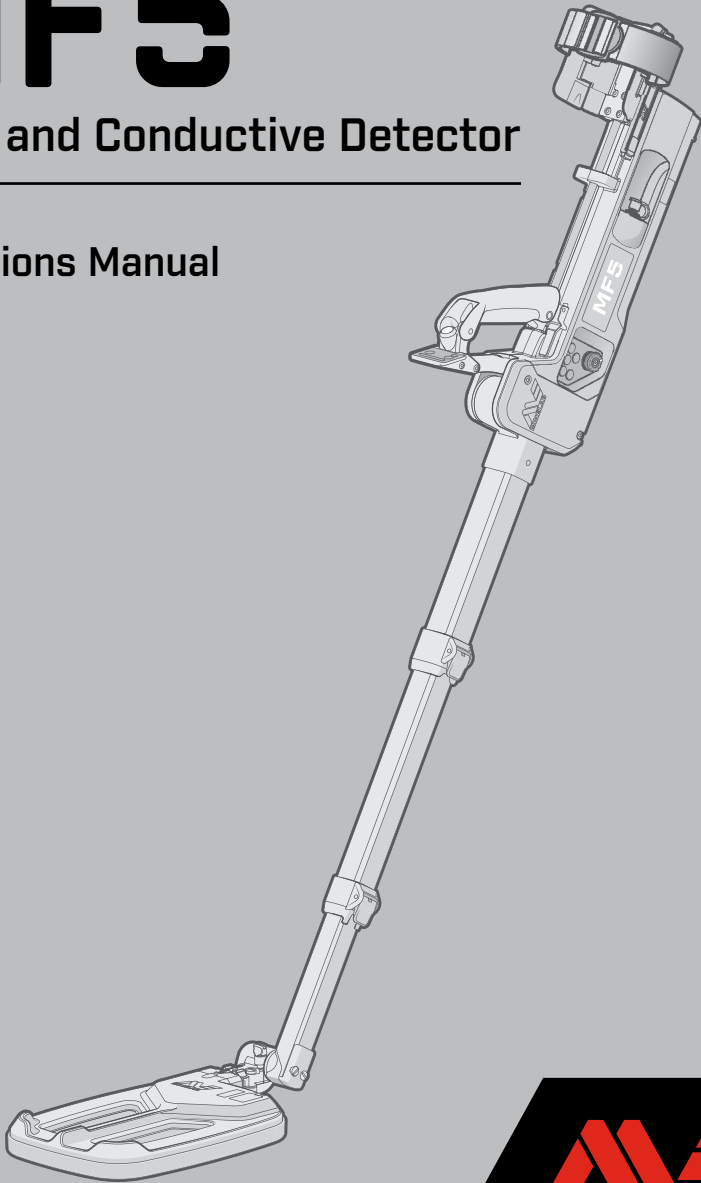

DISCLAIMER

THIS DOCUMENT CONTAINS INTELLECTUAL PROPERTY, TECHNICAL AND PROPRIETARY DATA AND INFORMATION AND OTHER MATERIAL OWNED SOLELY BY MINELAB ELECTRONICS PTY LIMITED. THIS MATERIAL MUST NOT BE USED WITHOUT THE PRIOR WRITTEN PERMISSION OF MINELAB ELECTRONICS PTY LTD.

@ Minelab Electronics Pty Ltd. All Rights Reserved.

This document is protected by copyright. Apart from any use permitted under the Australian Copyright Act 1968 (Cth) or other applicable laws, any unauthorised use, appropriation or reproduction of this document or any part of it is strictly prohibited. No part of this document may be used or reproduced by any means or by any process, in any form, without the prior written permission of the copyright owner Minelab Electronics Pty Ltd of 2 Second Avenue, Mawson Lakes SA 5095, Australia.

Patents and Trademarks

Patents may apply to this product: www.minelab.com/patents

MINELAB® and MF5® are trademarks of Minelab Electronics Pty. Ltd.

MF5

Metal and Conductive Detector

Operations Manual

Contents

System Overview

MF5 Overview	6
Detecting Set	7
Standard Items	7
Optional Items	7
MF5 Main Detector Parts	8
MF5 Detector	9

Getting Started

MF5 Preparation	10
------------------------------	-----------

Functional Description

Basic Functions	14
Additional Functions	17
Functional Tones	18

Procedures

Operating Procedures	21
Standard Procedure	21
Optional Procedures	23
Sensor Modes	25
Detection Mode	25
Interrogation Mode	25
Pinpoint Mode	26
Sensor Overload	26

Search Techniques

Search Technique	27
Search Speed	27
Search Overlap	27
Search Height	27

Locating the target.....	28
Sensor Head Null Zone	28
Coil Orientation	28
Target Edge Mapping	29
Target Edge Mapping Procedure	29
Target Pinpointing	29
Mapping Multiple Targets	30
Operating Multiple Detectors in Close Proximity	30

Troubleshooting, Safety and Maintenance

Routine Care	31
Troubleshooting	32
Advisory Errors	33
General Error and Coil Error	33
Initial Action	33
Safety Advice.....	34

Specifications

MF5 Detector Specification.....	36
--	-----------

MF5 Overview

Since 1996, Minelab has designed, developed and manufactured its range of metal detectors to meet the requirements of landmine, unexploded ordnance and Improvised Explosive Device (IED) clearance operations throughout the world. Minelab continually strives to improve equipment detection capability and Operator safety throughout the development of its unique technologies and products.

Performance

Minelab's MF5 metal detector has a uniquely simple and ergonomic design. The detector is reliable, robust and simple to use, allowing an Operator to focus on detecting targets. The MF5 is designed to detect and pinpoint all types of metal and conductive targets to include fine wires and carbon rods. Using complex interrogation algorithms, the MF5 can also provide an Operator with information regarding target composition.

Simple

The MF5 is designed for simple and intuitive use by an Operator thereby reducing the time required for equipment training.

Target detection alerts provided to an Operator can be a combination of audio (Main Speaker and/or Earset), visual (visible or Infrared [IR] Light Emitting Diodes [LED]) and haptic (vibration) responses. An Operator can select IR LED when operations require the use of night vision goggles.

Safe

This manual describes procedures for the safe and effective operation of the MF5. However, local Standard Operating Procedures should take precedence provided all Minelab recommended safety procedures are observed.

The MF5 incorporates several safety features such as Low Battery and System Fault warnings with continuous microprocessor controlled internal self-testing. The inclusion of a Test Piece provides the Operator with a quick and easy check to ensure the detector is functioning at its operational capability.

Robust

Components of the MF5 are manufactured within tightly controlled parameters so that they can be interchanged in the field without any requirement for calibration. The MF5 is designed to comply with MIL-STD-810G.

NOTE: Although the MF5 can withstand immersion to a depth of three metres for short periods of time — it is NOT designed for use as an underwater detector.

Detecting Set

The MF5 is supplied as a detecting set with the following items:

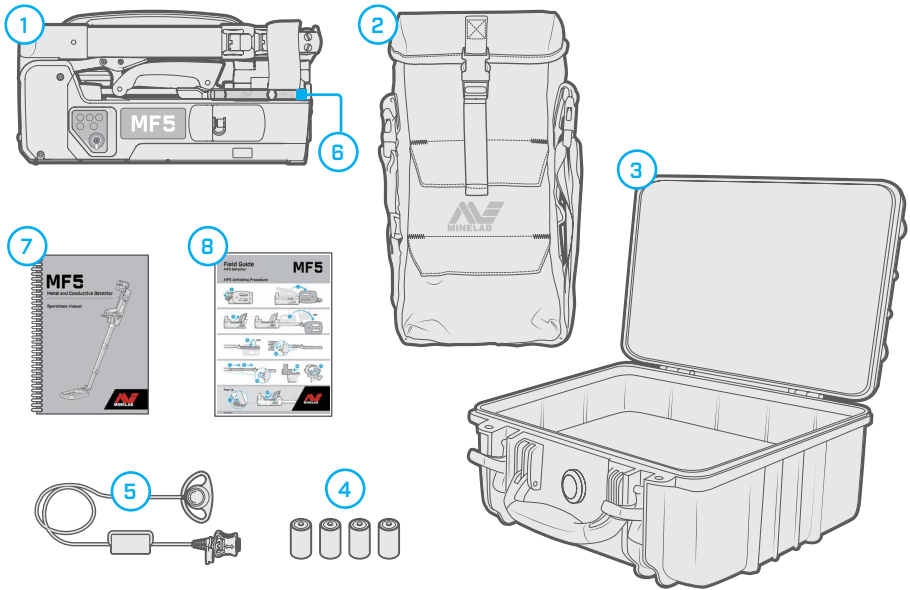

Standard Items

1. MF5 Detector
2. Carry Bag
3. Hard Transit Case
4. C cell Batteries (NiMH or Alkaline × 4)
5. Earset
6. Test Piece
7. Operations Manual
8. Field Guide

Optional Items

(not shown)

Battery Charger and Cables

Battery Charger Carry Bag

Audio Adaptor Cable

The Hard Transit Case stores the detector inside the Carry Bag and protects the detector when in transit or placed in storage.

The Carry Bag allows the Operator to comfortably carry the detector when use of the Hard Case is impractical.

The Carry Bag is not suitable for use when transporting the detector by road or air. For added protection during road or air transport it is recommended that the MF5 be packed in the Hard Transit Case.

NOTE: Items and specifications may vary from those shown and are subject to customer specific requirements.

MF5 Main Detector Parts

Major component parts of the MF5 include:

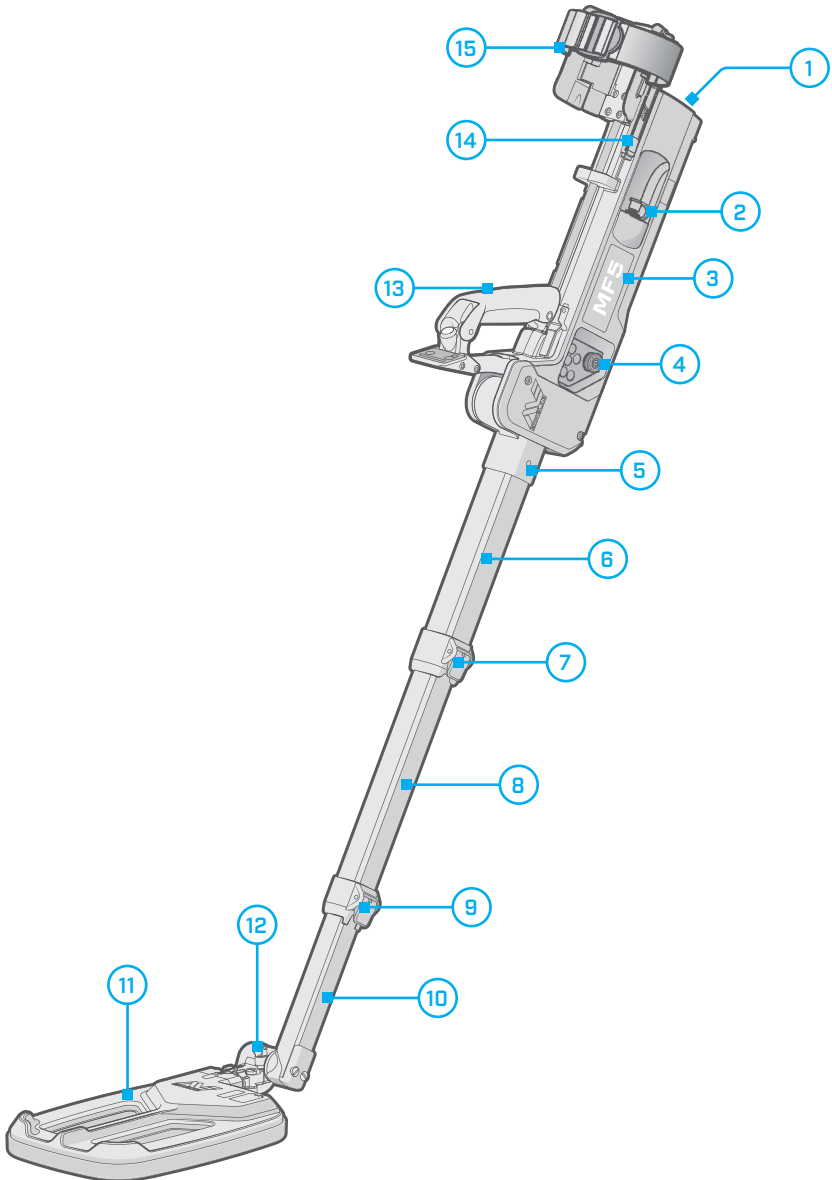

MF5 Detector

9. Battery Compartment

10. Earset Connector

11. Main Body

12. Controls

13. Shaft Hinge

14. Upper Shaft

15. Upper Camlock

16. Middle Shaft

17. Lower Camlock

18. Lower Shaft

19. Coil

20. Coil Pivot Assembly

21. Handle Assembly

22. Test Piece

23. Armrest and Strap

Battery Compartment

Contains four NiMH Rechargeable C Cell or Alkaline batteries. A battery map is provided to indicate correct alignment of batteries when inserted into the compartment.

Earset Connector

Provides connection for the Earset.

Main Body

Waterproof housing containing the detector electronics and batteries.

Controls

Sensitivity knob and keypad containing Power, Volume UP / Down / Mute, Vibration and LED Buttons.

Shaft Hinge

Pivot point for unfolding or folding the shafts. The hinge is only locked in position when the Handle Assembly is in its deployed position.

Upper, Middle & Lower Shafts

Carbon fibre shafts that are adjustable for Operator comfort and for changes in operating positions.

Upper & Lower Camlocks

Self-cleaning locking mechanisms to secure middle and lower shafts.

Coil

Waterproof open web coil which can be rotated 270 degrees.

Coil Pivot Assembly

Permits the tilt and rotation of the Coil and provides a tension screw for adjustment as required.

Handle Assembly

Collapsible handle that contains user interface buttons and LED display and a latch to permit quiet set-up and collapse.

Test Piece

Conveniently stowed on the Armrest to allow the Operator to ensure the detector is working at its operational capability.

Armrest & Strap

Provided for Operator comfort when the detector is used for prolonged periods. The Armrest can also be extended for Operator comfort.

MF5 Preparation

To prepare the detector for use, conduct the following procedure:

1. Remove from the case / bag

Open the Hard Transit Case and / or Carry Bag.

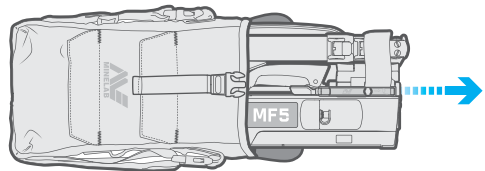

2. Inspect for damage

Inspect for obvious signs of damage. If damage is evident, report to the supervisor / team leader.

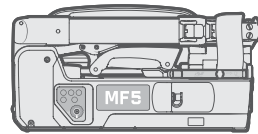

3. Insert batteries

Unlock the Battery Compartment Lid by twisting the Battery Locking Lever counter clockwise one-quarter turn. Once unlocked, pull the lid away from the Battery Compartment – the lid will stay attached by a tether.

Using the battery map located on the side of the Main Body, insert four C cell batteries. Taking care not to snag or trap the tether, replace the Battery Compartment Lid and rotate the Battery Lock Lever clockwise one-quarter turn. If the batteries are inserted incorrectly, the detector will fail to function when switched on.

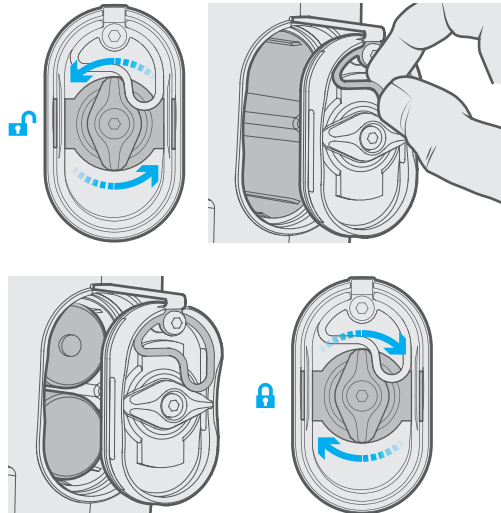

4. Unfold and adjust

- a. Slide down armrest strap
- b. Fold out coil and shafts
- c. Slide handle up
- d. Extend coil outwards
- e. Rotate coil 270°
- f. Unlock camlocks
- g. Extend shafts then lock camlocks
- h. Slide back armrest
- i. Adjust armrest and strap

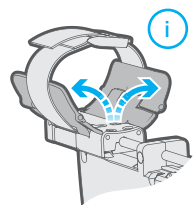
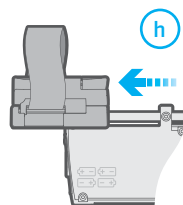
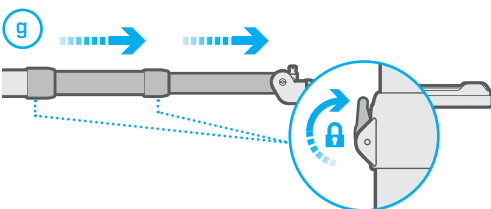
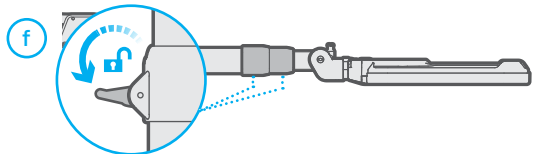
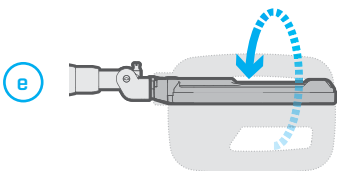
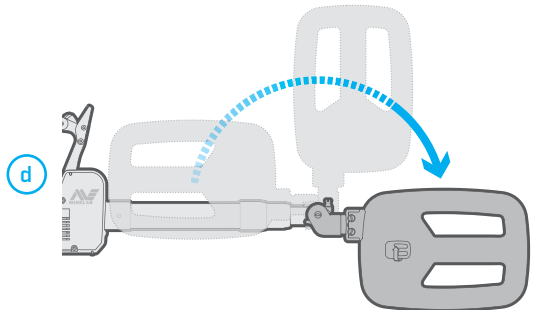
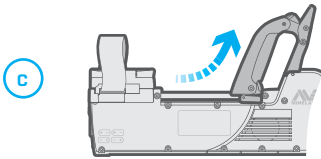
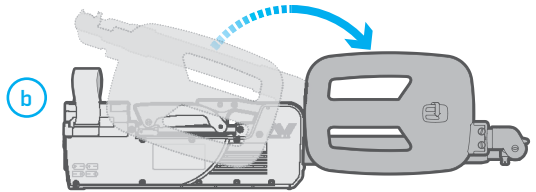
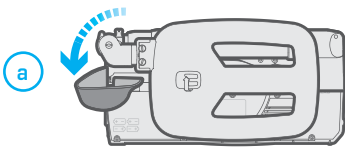

MF5 Preparation *(continued)*

5. Extend for operation

Extend the Lower and Middle Shafts to suit standing, kneeling or prone operating positions.

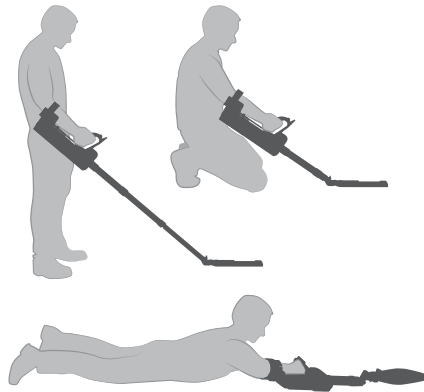

NOTE: The MF5 requires four C cell batteries for operation. Use only high quality NiMH rechargeable or Alkaline batteries. Minelab recommends that only rechargeable batteries with capacity of 4000 mAh or greater to be used with the MF5.

Rechargeable batteries have specific charge / discharge maintenance requirements which should be strictly followed to ensure maximum battery life

- Do not mix old and new batteries.
- Do not mix different battery brands.

NOTE: Electronics within the MF5 ensure that its performance remains consistent as the charge state of the batteries begins to reduce. A Battery Low Alarm will occur when there is approximately 30 minutes of battery life remaining.



Important Safety Warnings and Advice: When the Critically Low Battery Alarm occurs the Operator must immediately STOP operations. The MF5 should be switched off and new or recharged batteries inserted.



CAUTION — Risk of explosion if battery is replaced by an incorrect type.

6. Connect Earset

Undo the dust caps from the Earset Plug and Earset Socket on the detector. Gently hold the Earset by the rubber collar using thumb and index finger, the raised double arrow should be uppermost. Align the plug with the Earset Socket and firmly slide the collar onto the socket.

The MF5 is now ready for operations.

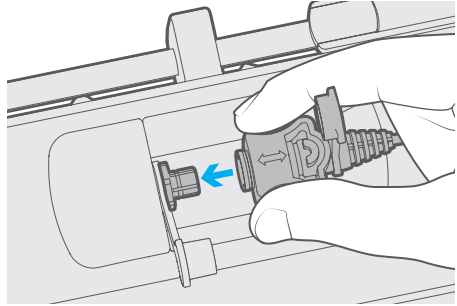

NOTE: The Earset Connector is waterproof and must be connected and disconnected from the Earset Socket by holding the rubber collar.

Do not attempt to connect or disconnect the Earset by pushing or pulling on the strain relief or wire at the rear of the rubber collar.

Pack up

To repack the MF5, reverse the preparation procedure. Lifting the latch and gently sliding the handle back allows for quiet stowage of the handle assembly.

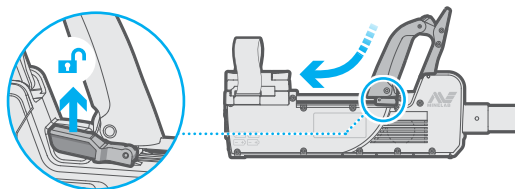

Basic Functions

For ease of use, all controls and displays for the MF5 are located on the Handle Assembly and Main Body.

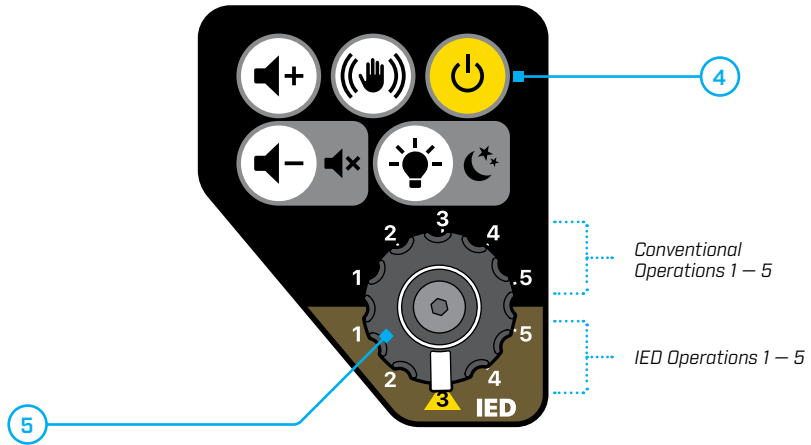
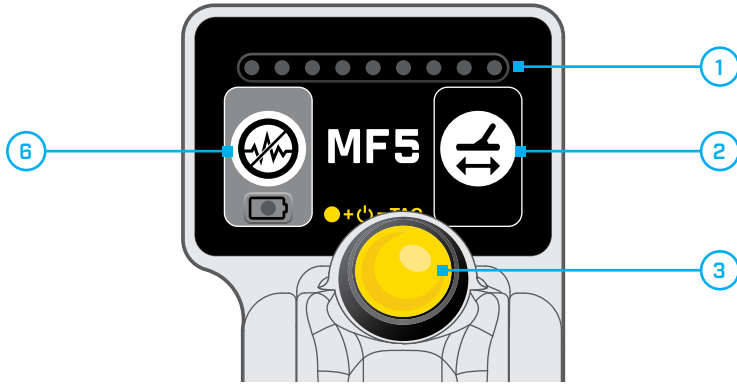

Dual Function

Several buttons have a dual function as notated on the decal icon. For example, the Volume Down Button can also be used to mute the audio. Where a button has a dual function:

Short-press (< 0.5 s) the primary function.

Long-press (> 0.5 s) the secondary function.

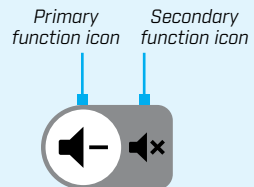

1. LED Display

A display of nine LED provides a visual indication of detection signal strength when in Detection and Pinpoint Modes and information regarding target composition when in Interrogation Mode.

2. Ground Balance Button

Ground Balance should be conducted every time the MF5 is switched ON and when first changing between IED and Conventional Operations or vice versa. The automated Ground Balance procedure removes interference or false alarms from mineralised soils and rocks whilst maintaining sufficient sensitivity to detect targets of interest.



NOTE: Whenever the MF5 is restarted, the previous Ground Balance condition is retained although a new Ground Balance is recommended.

3. Mode Button (Yellow)

The MF5 operates in one of three sensor modes:

- **Detection Mode:** Detection Mode is the default sensor mode to be used for detecting all targets. It is the most sensitive mode.
- **Interrogation Mode:** By pressing and releasing the Mode Button once, the MF5 will enter into Interrogation Mode which provides additional target information to the Operator.
- **Pinpointing Mode:** By pressing and holding the Mode Button, the MF5 will enter Pinpointing Mode, which assists the Operator to accurately map and pinpoint the target. When the Mode Button is released, the MF5 will revert to Detection Mode.

4. Power Button

To switch the MF5 ON or OFF, Long Press (> 0.5 s) Power Button. The MF5 will complete start-up procedures and internal diagnostics to ensure the detector is operational and working within design parameters. By default, the MF5 will commence in Detection Mode and emit a double-tick heartbeat every 15 seconds.

5. Sensitivity Knob

The MF5 can be operated in one of five sensitivity levels in either Conventional or IED Operations. To select a sensitivity level, the Sensitivity Knob must first be lifted slightly and then rotated.

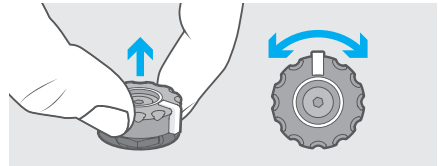

The need to first lift the Sensitivity Knob prevents accidental or inadvertent changes to sensitivity without the Operator's knowledge.

- **IED Operations (Default):** IED Operations should be selected when searching for all types of targets including carbon rods and fine wires.
- **Conventional Operations:** Conventional Operations result in the MF5 being less sensitive to carbon rods and wires and is most suitable for the detection of metal contained in conventional ordnance or landmines. Conventional Operations is also more effective when searching in ground with high salt content; for example beach areas.

After switching on the MF5 in IED or Conventional Operations a Ground Balance procedure must be conducted.

NOTE: After switching on the MF5, when selecting IED or Conventional Operations for the first time, a Ground Balance procedure should be completed. Provided the detector is not Factory Reset, subsequent selections of IED or Conventional Operations do not require another Ground Balance.

When the detector is switched off, Ground Balance profiles for IED and Conventional Operations are retained.

When conducting the Test Piece procedure, select sensitivity Level 3 in either IED or Conventional Operations.



Warning: When detecting targets with low metal signatures, the sensitivity level must not be lower than Level 3 in either IED or Conventional Operations.

6. Noise Cancel Button

Noise Cancel should be conducted whenever the MF5 receives interference from electrical sources such as power lines, generators or other detectors operating in close proximity.



7. Target Alert Responses

An Operator can be alerted to a target by audio, visual (LED), or haptic (vibration) responses. All three alert responses can be enabled or individually selected by the Operator.

8. Tactical Mode

The Operator has the option of selecting Tactical Mode at anytime during the operation of the MF5 or when the detector is switched ON. Tactical Mode provides a vibration alert response which can be deselected if required. In Tactical Mode, the LED display is changed to IR for use with night vision goggles.

NOTE: For safety purposes it is impossible to disable all three target alert responses simultaneously.

It is recommended that the audio alert response be enabled at all times unless the tactical situation dictates otherwise.

9. Battery Alarms

The MF5 battery status can be checked at anytime (see Additional Functions on page 17). Warning will be provided to the Operator whenever the following conditions occur:











- **Low Battery Alert:** When using NiMH batteries a Low Battery Warning will occur when approximately 30 minutes of NiMH battery life remains. The alarm, via the enabled alert responses, will be provided every 45 seconds. During this period, the MF5 will continue to function within operational limits.
- **Critically Low Battery Warning:** Continuous alarm via the enabled alert responses and the MF5 can no longer be used.
- **Battery Shutdown:** The MF5 is shut down due to lack of battery power.



Warning: Once the Low Battery Warning occurs, batteries should be replaced immediately or as soon as possible before the Critically Low Battery Warning occurs.

Additional Functions

The MF5 provides additional functionality which can be selected at any time during operations as required.

Function	Action	Outcome
<i>Volume Up</i>	 Short Press (< 0.5 s)	Raise volume level from 1 to 9 (Default is 6).
<i>Volume Down</i>	 Short Press (< 0.5 s)	Decrease volume level from 9 to 1 (Default is 6).
<i>Volume Mute</i>	 Long Press (> 0.5 s)	Mutes main speaker but not the Earset when connected. Long press to un-mute.
<i>Vibration ON / OFF</i>	 Short Press (< 0.5 s)	Toggles handle vibration ON and OFF.
<i>LED Display ON / OFF</i>	 Short Press (< 0.5 s)	Toggles LED display ON and OFF.
<i>LED display Visual / Infrared ON / OFF</i>	 Long Press (> 0.5 s)	Toggles LED display between Visual or IR (Infrared)
<i>Tactical Mode</i>	 +  Press and hold Mode Button then the Power Button	After two short vibrations release both Buttons. Main speaker muted, IR LEDs activated, vibration activated. Audio available via Earset if required.
<i>Battery Status</i>	 Turn LED Display on. Long Press (> 0.5 s) the Noise Cancel button	Battery status indicated on LED display for three seconds.
<i>Factory Reset</i>	 Press and Hold Power Button for > 5 s on startup	MF5 initiates with: <ul style="list-style-type: none"> • Detection Mode • Audio ON • Vibration OFF • LED Display Off • LED Display set to Visual (not IR) • Volume Level 6

NOTE: Unless Factory Reset is conducted, or the MF5 starts in Tactical Mode, the MF5 will operate using the previously selected additional functions when restarted.

Battery Status indication will be accurate for NiMH batteries but not for other battery chemistries.

Functional Tones

The MF5 emits tones that vary in pitch and volume to alert the Operator to targets, automatic detector functions or equipment alarm conditions. The following table summarises the tones emitted by the MF5.

Tone	Event	Description
<i>Start-Up</i>	Internal diagnostic checks when the MF5 is switched on.	Slow repeating low-pitched beep.
<i>Shut-Down</i>	Unit powering down and settings saved.	Low-pitched descending tones.
<i>Heartbeat (Detection Mode)</i>	Indicates that detector is operating in Detection mode.	Double tick every 15 seconds (only occurs in the absence of other audio, such as detection audio or low battery warning).
<i>Heartbeat (Interrogation Mode)</i>	Indicates that detector is operating in Interrogation mode.	Single tick every 15 seconds (only occurs in the absence of other audio, such as detection audio or low battery warning).
<i>User Input Accepted</i>	Confirms to Operator that user input has been accepted.	Single short beep of high-pitch.
<i>User Input Not Accepted</i>	Indicates to Operator that user input has not been accepted.	Single short beep of low-pitch.
<i>Success</i>	Confirms to Operator that a process has been successfully completed (for example Noise Cancel, Ground Balance).	Three short beeps of ascending pitch.
<i>Failure</i>	Indicates to Operator that a process has failed (for example Noise Cancel, Ground Balance).	Three short beeps of descending pitch.
<i>Ground Balance</i>	Indicates that Ground Balance is in progress.	Four short high-pitch beeps followed by one relatively lower pitch beep, on a repeating cycle.
<i>Noise Cancel</i>	Indicates that Noise Cancel procedure is in progress.	A repeating cycle of two short high-pitched beeps followed by a longer lower-pitched beep.
<i>Target Detection</i>	Indicates target detected.	Increases volume and high or low-pitch depending on target composition and depth.

Tone	Event	Description
<i>Mode Change</i>	Entering or exiting Interrogation or Pinpoint Mode.	When entering Interrogation Mode a single mid pitched beep. When exiting Interrogation Mode a double mid pitched beep.
<i>Interrogation Mode: Ferrous Target</i>	Indicates target likely to be ferrous.	Single beep with very low-pitched tone.
<i>Interrogation Mode: Carbon Rod / Fine Wire</i>	Indicates target likely to be carbon rod or fine wire.	Single beep with very high-pitched tone.
<i>Interrogation Mode: Non-Ferrous Target</i>	Indicates target likely to be non-ferrous.	Medium to high-pitched tone proportional to the target conductivity.
<i>Pinpoint Mode</i>	Indicates proximity of target to centre of coil via a static response such that the target feedback will be heard even if the detector coil is stationary with respect to the target.	Increasing to the maximum pitch when the detector coil is immediately adjacent to the target centre.
<i>Ground Balance IED Operations</i>	Indicates that Sensitivity knob has been changed into IED Operations from Conventional Operations.	One higher pitched beep followed by one lower pitched beep.
<i>Ground Balance Conventional Operations</i>	Indicates that Sensitivity knob has been changed into Conventional Operations from IED Operations.	One lower pitched beep followed by one higher pitched beep.
<i>Default Sensitivity Selected</i>	Confirms to Operator that Sensitivity knob is at Position IED 3 (Default) when the detector is switched on or Position IED 3 is selected whilst the detector is in use.	Double mid-pitched beep.
<i>Sensitivity Not Default</i>	Indicates that the default sensitivity is not selected when detector is switched on.	Single low-pitched beep if sensitivity lower than default (IED 3) and single high-pitched beep if sensitivity higher than default.
<i>Changing Sensitivity</i>	Increasing or reducing sensitivity.	When increasing sensitivity a single high-pitched beep, except when increased to default value. When decreasing sensitivity a single low-pitched beep, except when decreased to default value.
<i>Volume Default</i>	Indicate that the volume setting is set to the default value.	Double beep at volume 6.

Tone	Event	Description
<i>Changing Volume</i>	Increasing or reducing volume.	Mid-pitch single beep with volume dependent on setting, except when changed to default value.
<i>Low Battery Alert</i>	Indicates battery charge is low and detection time is limited.	Two high-pitched tones every 45 seconds.
<i>Battery Critically Low</i>	Indicates that batteries do not have enough charge to continue detection.	High-pitched fast continuous oscillating tone PLUS blinking Battery Low LED provided the LED display is switched on.
<i>Overload</i>	Indicates that the receiver electronics are overloaded.	Continuous low-pitched tone.
<i>Equipment Fault</i>	Indicates failure of detector component.	Low-pitched slow oscillating tone (ee-aww, ee-aww).
<i>Coil Fault</i>	Indicates coil not connected or not receiving sufficient current.	Low-pitched double tone every five seconds.
<i>Advisory Error</i>	Indicates the operating conditions are not ideal but will not affect detector performance.	Low-pitched tone repeated every 30 seconds (ee-aww).

Operating Procedures

The MF5 is designed to ensure that the operation of the detector is as simple and intuitive as possible thereby eliminating the need for lengthy training requirements.

Local Standard Operating Procedures and drills should take primacy provided Minelab recommended safety procedures are observed.

Standard Procedure

After preparing the MF5 for operations, complete the following THREE step standard procedure:

STEP 1: Switch On

- Hold the coil at least 600 mm (24 in) from the ground, and away from any metallic objects.
- Ensure Sensitivity is set to Level 3 (default).

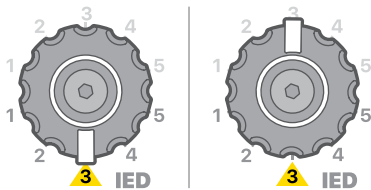

- Long press (> 0.5 s) the Power Button.



The MF5 will emit a series of start-up tones and finish with either a double ACK beep (default sensitivity – Level 3) or single ACK beep (non-default sensitivity).

NOTE: If the audio alert response is disabled, either of the remaining alert responses will provide applicable feedback.

If the detector is noisy or affected by interference, perform a Noise Cancel as described in Optional Procedures on page 23.

STEP 2: Ground Balance

- Ensure this procedure is carried out on ground that contains no metal targets, and is representative of the ground in the intended search area.

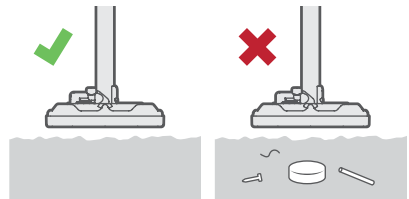

- Short press the Ground Balance Button to initiate the Ground Balance process. During ground balance, the ground balance tones / vibration / LED pattern will indicate that ground balance is in progress.



- Sweep the Coil left and right across the metal-free ground. Covering more ground will improve the resulting ground balance.

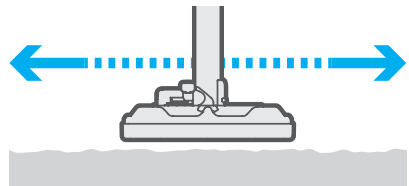

- d. After eight seconds, there will be a success tone / vibration / LED pattern and the detector will return to Detection Mode. If the Ground Balance procedure was not successful, there will be a failure tone / vibration / LED pattern depending on which alert responses are enabled.
- e. Sweep the Coil back over the metal-free ground checking for any ground noise or false detections. Repeat Ground Balance if required.

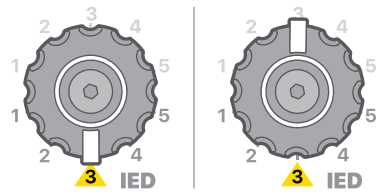

- c. Fully slide back the Armrest and rotate the Test Piece to remove it from its stowed position.

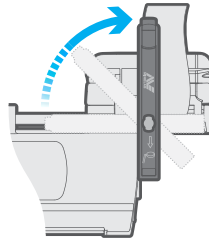

- d. Hold the Test Piece by the end that contains the metal test-target.



Hold the Test Piece perpendicular to the bottom of the Coil, lightly touching the surface of the Coil with the tip of the Test Piece. Move the Test Piece across the Coil from one side to the other at a rate of 0.5 to 1 m/s (1.7 to 3.3 ft/s)

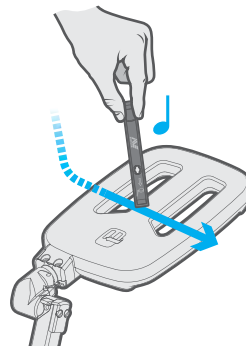

NOTE: After switching on the MF5, when selecting IED or Conventional Operations for the first time, a Ground Balance procedure should be completed. Provided the detector software is not upgraded, subsequent selections of IED or Conventional Operations do not require another Ground Balance.

When the detector is switched off, Ground Balance profiles for IED and Conventional Operations are retained.

Completing the Ground Balance procedure may allow the selection of a higher sensitivity level due to reductions in ground noise and false detections.

STEP 3: Test Piece Procedure

NOTE: The MF5 is supplied with a Test Piece designed to confirm that the detector is working to correct specifications. The sensitivity of the detector should be checked with the Test Piece when the Sensitivity Knob is at Level 3 for either IED or Conventional Operations.

- a. Ensure hands and arms are free of metallic objects (watches, rings, etc.) and that no other metallic objects are near the Coil.
- b. Select sensitivity Level 3 in either IED or Conventional Operations.

A faint but clear response (a rise in volume) should be heard. With the LED display enabled, the Test Piece procedure should result in the illumination of at least one LED. If a clear response cannot be heard, increase the volume level of the detector until the Test Piece procedure is successful.

If the Test Piece does not produce a response, Factory Reset the detector and repeat the Test Piece procedure.

If after increasing the volume level of the detector the Test Piece response cannot be heard, increase the sensitivity level of the detector to Level 4, Ground Balance and repeat the Test Piece procedure.

NOTE: In some instances, inert mines or targets may be used as test pieces because they represent the local threat. Minelab recommends that the MF5 always be first tested with the supplied Test Piece before the use of local test pieces.

 **Warning:** If the Test Piece procedure fails, the detector is faulty and must NOT be used in operations.

Optional Procedures

Noise Cancel

- a. Hold the Coil stationary and away from the ground and metal targets.

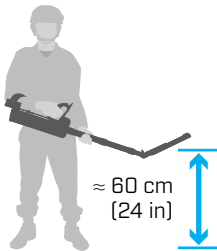

- b. Short-press the Noise Cancel Button to initiate the Noise Cancel process.



Holding the detector stationary the Noise Cancel tone / vibration / LED pattern will indicate that Noise Cancel is in progress.

After 25 seconds, Noise Cancel will finish. The detector will play a success tone / vibration / LED pattern depending on which alert responses are enabled.

Enable LED Display and Vibration Alert Responses.

If the detector is operating with audio alert response only, the LED display and vibration alert responses can be enabled as follows:

- **LED Display:** Short press the LED Button on the Main Body.
- **Vibration:** Short press the vibration Button on the Main Body.

Once Noise Cancel is complete, continue with Standard Procedure Steps 2 and 3.

NOTE: If the MF5 is restarted, it remembers the Noise Cancel setting and therefore another Noise Cancel may not be required.

Alert Responses and Heartbeat Ticks

Heartbeat ticks will be given depending on the alert responses enabled by the Operator. However, only one type of heartbeat tick will be provided based on the following alert response selection combination.

Selected Alert Responses	Heartbeat Tick Response
Audio	Audio
Audio, LED	Audio
Audio, LED, Vibration	Audio
LED	LED
LED, Vibration	LED
Vibration	Vibration

STEP 1
Switch on

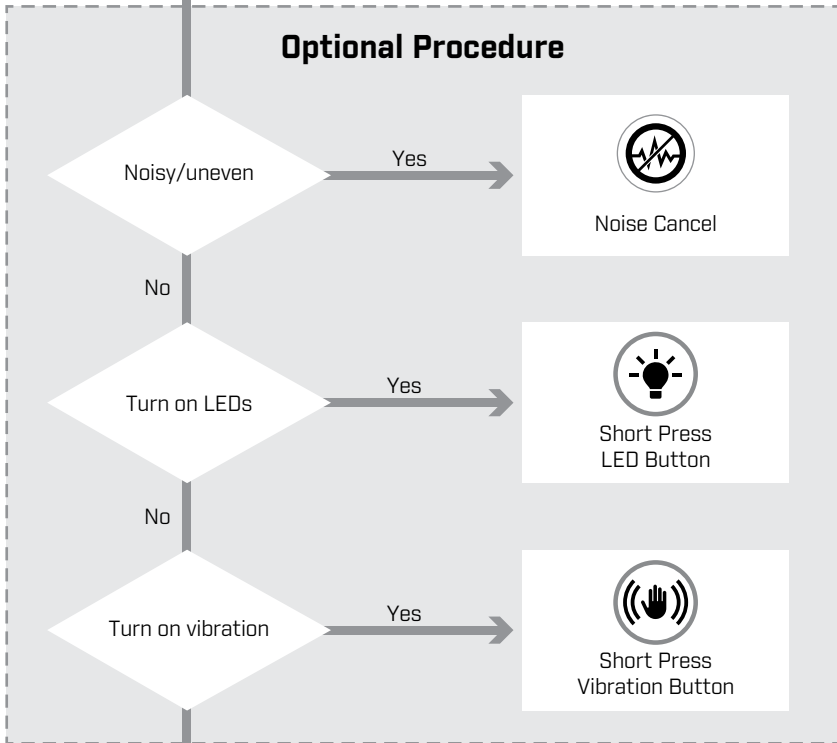
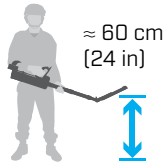

STEP 2
Ground Balance

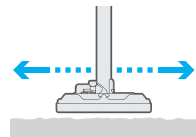
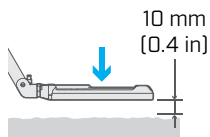

STEP 3
Test piece

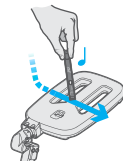

Sensor Modes

The MF5 may be operated in the following sensor modes:

Detection Mode

Detection Mode is optimised for maximum detection performance and is the default mode used for searching new ground. In Detection Mode, a double-tick heartbeat is emitted every 15 seconds via the applicable alert response.

When in Detection Mode the MF5 operates as a dynamic detector meaning the Coil must be moving relative to the target in order to register a detection response.

The audio alert response will have pitch and volume that is proportional to the target's signal strength. Large and / or close targets will be loud / high-pitched and small and / or deep targets will be quieter / low-pitched.

NOTE: Detection Mode is more sensitive than Interrogation Mode and Pinpoint Mode. Therefore, very small targets detected in Detection Mode may not be detected when using Interrogation Mode or Pinpoint Mode. If this occurs, use Detection Mode to locate the target rather than Pinpoint Mode.

Interrogation Mode

Once a target is detected the Operator may select Interrogation Mode by short pressing the Mode Button. This will provide additional information about the target which may be useful.

When in Interrogation mode, a single-tick heartbeat is emitted every 15 seconds.

When in Interrogation Mode the audio response is based on the characteristics of the target and not the target size and proximity, as is the case with Detection Mode.



Warning: Interrogation mode only provides information on the characteristics of a target and is incapable of providing conclusive target identification. The MF5 cannot distinguish between a target of interest and another target that has similar metallic properties.

Ferrous Targets: Ferrous (Iron) targets will give a very low-pitched beep tone and low intensity vibration. The LED target response for a ferrous target is displayed as 1 to 8 LEDs illuminated left to right. The number of illuminated LED indicates the level of conductivity of the target.



Non-Ferrous Targets: Non-ferrous targets give a medium to high-pitched beep tone depending on target conductivity (higher pitch corresponds to higher conductivity). The vibration intensity is scaled to match the audio pitch. The LED target response is displayed as 1 to 8 LED illuminated from right to left. The number of LEDs illuminated indicates the level of conductivity of the target.



Carbon Rod and Fine Wires. Carbon rods or fine wires often used in IEDs exhibit low conductivity resulting in a very high-pitched audio tone and high intensity vibration. In this instance the centre three LED will be illuminated.



Pinpoint Mode

Pinpoint Mode permits a fast and accurate method of precisely mapping a target. By pressing and holding the Mode Button the MF5 enters into Pinpoint Mode providing a static response to a target. This means a detection alert response will occur even when the Coil is stationary over a target. There are no heartbeat ticks in Pinpoint Mode.

When the Mode Button is released, the detector will return to Detection Mode.

NOTE: It is not necessary to enter Interrogation Mode prior to Pinpoint mode. There may be instances where local ground conditions and contamination limit the additional information Interrogation Mode can provide.

Sensor Overload

When operating any of the Sensor Modes (Detection / Interrogation / Pinpoint), large metal objects very close to the Coil may overload the detector. Sensor overload is an indication that the target is larger than the detectors maximum target response.

If this occurs, then depending on the enabled alert responses, the:

- vibration motor will pulse repeatedly
- LED will strobe
- overload tone will repeat

Sensor overload will continue until the Coil is moved away from the location of overload.

Sensor overload is not harmful to the MF5 electronics.

Search Technique

Once the MF5 has completed the Standard and, if necessary, Optional Procedures then searching an area can commence.

Search Speed

In Detection Mode, the MF5 should be swept with a smooth and even motion ideally between 0.5 and 1 m/s (1.7 and 3.3 ft/s). If the detector is swept too fast or too slow then it is possible that small or deep targets may be missed.

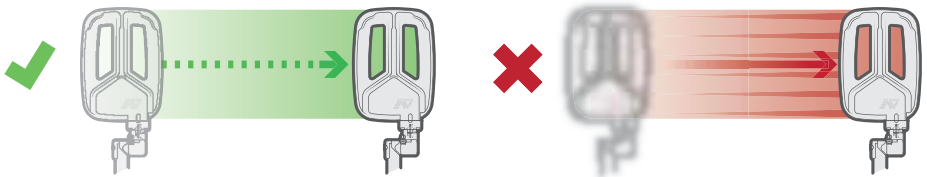

Search Overlap

Use a half-Coil (13 cm, 5 in) overlap distance to ensure full ground coverage.

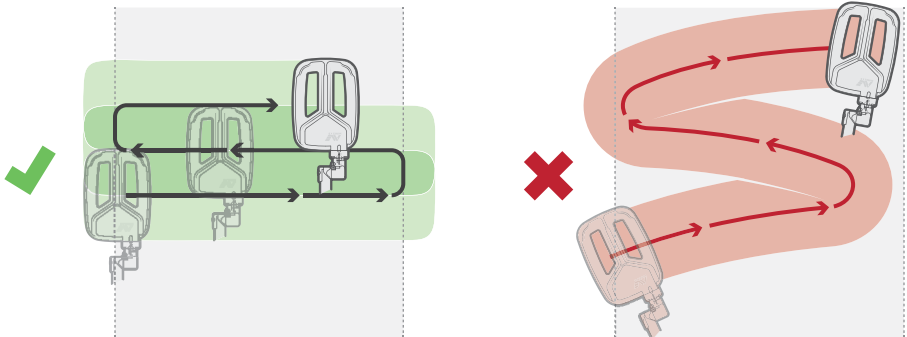

Search Height

Ensure that the Coil is swept as parallel to the ground as possible, at a height as close to the ground as practical without touching or impacting the ground. Depth of detection depends on the target distance from the Coil, not the depth of the target under the ground.

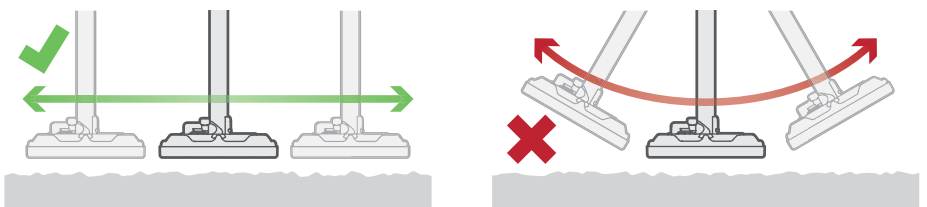

Locating the target

When a target is initially detected, the Operator should stand in place and continue to sweep beyond the target (Local Standard Operating Procedure [SOP] takes primacy) in an attempt to find clear ground beyond the target.

In doing so the Operator will:

- immediately gain an impression of the size of the target, prior to commencing mapping; and
- confirm the target is not in close proximity to a second target, thereby avoiding a possible booby trap.

Once the Operator has obtained an approximate idea of the size and position of the target, the target can be mapped for greater accuracy. Use the Target Edge Mapping and Target Pinpointing procedures to map the target.

Sensor Head Null Zone

The detection response increases to a maximum when the Coil is over the target centre when in Detection Mode. In Pinpoint Mode there is a maximum response when the target is below the left or right side of the coil (on both sides), with a 'null zone' precisely centred over the target.

Peak sensitivity zones

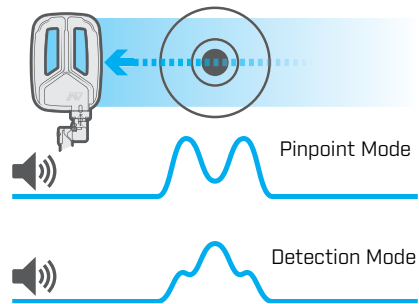
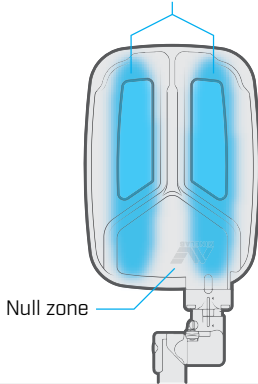

Coil Orientation

Approach targets with the long sides of the Coil.

Avoid using the back and front of the Coil to approach a target, as the target may not be detected, or may be inaccurately located.

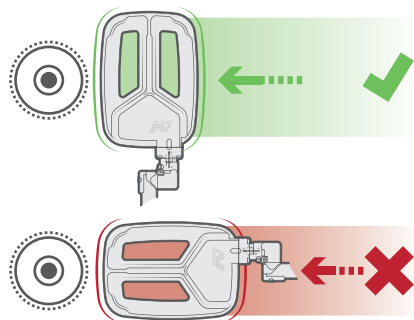

Target Edge Mapping

The Target Edge Mapping procedure uses an 'edge detection' technique to locate the outer edges of a target thereby mapping the size and shape of the target. Pinpoint and Detection Modes can also be used during the mapping process.

NOTE: Pinpoint Mode is slightly less sensitive than Detection Mode and may not work well for extremely weak target detections. In these instances, use Detection Mode to map the target. Where a target is small Target Edge Mapping may not be required and so proceed to Target Pinpointing.

Target Edge Mapping Procedure

1. Move the Coil away from the suspected area of the target and enable Pinpoint Mode by pressing and holding the Mode Button.
2. Move the Coil to approach the target area from a variety of angles.
3. When there is a target response, mentally mark the position on the ground.
4. Continue this process until a clear mental picture of the target size and shape is obtained.

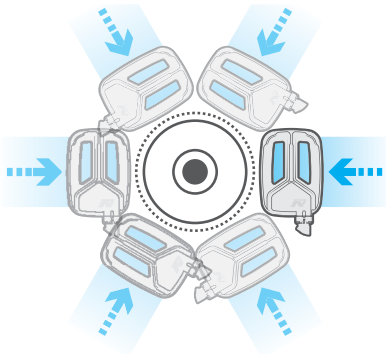

Warning: Extreme care must be taken when mapping the target to ensure the Coil does not touch the ground or exposed parts of the threat.

Target Pinpointing

Having mapped the area of a suspected target, the Target Pinpointing procedure can be used to determine the centre of a target.

1. Hold the Coil away from the mapped target and enable Pinpoint Mode by pressing and holding the Mode Button.
2. Sweep the coil over the target. The detector alarm response will increase to the maximum before reducing when the null zone on the Coil is directly above the target. Small Coil movements left and right of the null causing an alarm response will confirm the position of the target.
3. When the null point is reached mentally mark the centreline.

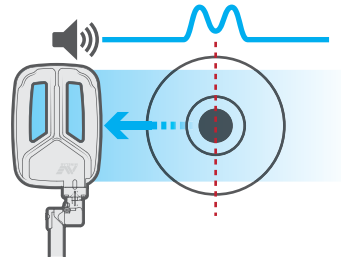

4. Repeat the process with the detector oriented at 90° to the first sweep. The intersection of the two lines will indicate the target location.

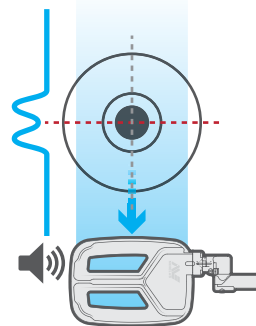

5. If necessary, enter Interrogation Mode to obtain or confirm information about the target composition.

Mapping Multiple Targets

There may be occasions when multiple targets are encountered in a small area. For example, small anti-personnel landmines may be buried in a cluster, or a large anti-tank landmine may be surrounded by smaller anti-personnel landmines or booby traps.

1. Using Target Edge Mapping procedure outline the suspected area.
2. After mapping out the area, select Pinpoint Mode and sweep across the area approaching from different angles. Separate alarm responses may occur indicating the location of different targets.
3. Once several targets have been pinpointed and, if necessary, select Interrogation Mode to obtain further information about each target.

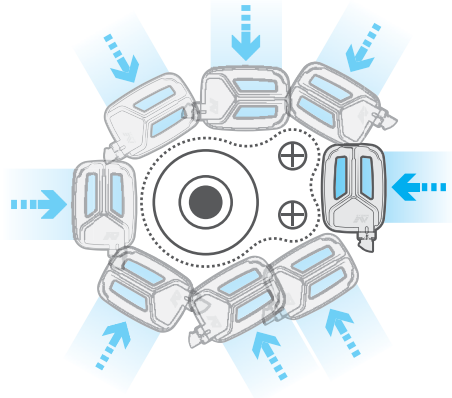

Warning: The volume from a large target may mask that of a small target if the small target is located too close to the large target.

Operating Multiple Detectors in Close Proximity

On occasion, it may be necessary to operate MF5 detectors in close proximity. In normal circumstances, MF5 detectors can operate at distances less than two meters (7 ft) separation without suffering excessive mutual interference.

To achieve the minimum operating distance between detectors, conduct Noise Cancel as follows:

1. With all other detectors switched OFF, switch ON the first detector and perform Noise Cancel.
2. Once Noise Cancel is finished on the first detector, leave it switched ON and locate the second detector at a distance of two metres and conduct Noise Cancel on the second MF5.
3. Repeat this process for all additional detectors.

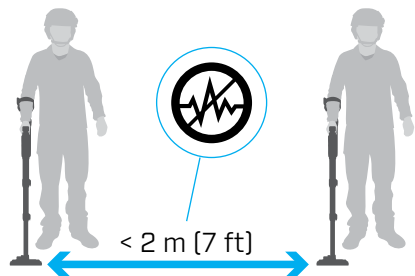

Routine Care

The MF5 is designed for prolonged use in harsh operating environments provided proper care and maintenance is conducted.

The following should be observed:

- Do not use solvents or chemicals to clean the MF5. If any part of the detector comes into contact with corrosive substances, wash the detector with clean fresh water and dry with a clean cloth.
- During rest periods, wherever possible, the detector should be sheltered from direct sun, rain, snow, etc.
- Before collapsing the shafts, fully extend each shaft and remove any dirt or dust with a damp cloth.
- Ensure the MF5 is dry before stowing in the Carry Bag.
- Ensure the batteries are removed from the Battery Compartment before stowing the detector.
- Check Earset and Test Piece are properly stowed.

Troubleshooting

The following is a troubleshooting guide in the event the MF5 displays a fault. Before commencing troubleshooting, perform a Factory Reset to confirm if the fault still exists.

Problem	Recommended Action
Detector will not switch ON	<ol style="list-style-type: none">1. Check batteries have been inserted correctly into the Battery Compartment.2. Replace the batteries with new or recharged batteries.3. Factory Reset the detector – press and hold the Power Button for five seconds on start-up.
Detector switched OFF / ON when bumped or shaken	<ol style="list-style-type: none">1. Remove and clean the batteries.2. Replace or recharge the batteries.
Detector switched ON but non-responsive / no feedback	<ol style="list-style-type: none">1. Switch the detector OFF.2. Factory reset the detector – press and hold the Power Button for five seconds on start-up.
No LED / Audio / Vibration	<ol style="list-style-type: none">1. Toggle Visual, Audio, or Vibration Buttons.2. Increase the Volume by pressing the Volume + Button.3. Factory Reset the MF5 – press and hold the Power Button for five seconds on start-up. Press the Vibration Button to enable the vibration feedback. Press the LED Button to enable the LED display.
No sound – Speaker	<ol style="list-style-type: none">1. Check the speaker is not muted, or mute and unmute the speaker.2. Increase audio volume3. Disconnect the Earset then switch the detector OFF and ON.4. Factory Reset the detector – press and hold the Power Button for five seconds on start-up.5. Check that the Earset is capable of producing sound. If the speaker still does not function but the Earset does the speaker or detector may be faulty.
No sound – Earset	<ol style="list-style-type: none">1. Check the Earset is properly connected.2. Remove the Earset and inspect the connectors for contamination or damage.3. Replace the Earset.4. Factory Reset the detector – press and hold the Power Button for five seconds on start-up.5. Check if the speaker is capable of producing sound. If it does it tends to indicate the Earset or its connector may be faulty.
Excessive detector noise	<ol style="list-style-type: none">1. Perform a Noise Cancel.2. Move away from the source of the noise.3. Lift the Coil away from the ground and any targets. If the noise is reduced conduct a ground balance.4. Reduce the detector sensitivity or switch to Conventional Operations.

Problem	Recommended Action
Cannot hear the Test Piece	<ol style="list-style-type: none"> 1. Ensure the Sensitivity of the detector is set to Level 3. 2. Ensure the detector is operating in Detection Mode. 3. Ensure the Audio is not muted. 4. Increase the Volume by pressing the Volume + Button. 5. Factory Reset the detector
Shafts stuck / do not move smoothly due to sand or dirt contamination	<ol style="list-style-type: none"> 1. Open camlocks and extend shafts fully. 2. Wipe the shafts clean with a clean damp cloth. 3. Collapse and extend shafts repeatedly, cleaning as necessary until shafts move smoothly.
Coil does not retain the set angle	<ol style="list-style-type: none"> 1. Tighten the Coil Pivot Tension Screw as required.
An advisory error, Coil alarm or general alarm occurs	<ol style="list-style-type: none"> 1. Switch the detector OFF then ON again.

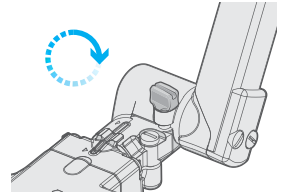

Advisory Errors

Advisory errors are conditions that will not affect detector performance. An advisory error is given when the control box temperature sensor is below or above range, or corrupted settings are loaded.

Advisory errors are indicated on all enabled feedback modes. These include a short error tune, LED bank illumination from right to left, and vibration pulses which repeat every 30 seconds.

The Operator may elect to continue detecting as normal in the presence of an advisory error.

General Error and Coil Error

The MF5 has a Built-in Test (BIT) capability for identifying faults and errors.

When a fault occurs, the MF5 will emit an alarm via enabled audio, vibration and visual responses.

Audio: A low-pitched double-tone will repeat every five seconds for a Coil fault, or a low-pitched oscillating tone will commence for general errors.

Vibration: Repeating two strong pulses of different durations.

Visual: Repeating alternating illumination of four right-hand LED followed by five left-hand LED (general error) or four right-hand LED followed by four left-hand LED (coil error).

Initial Action

Where a fault occurs, conduct the following initial action:

1. Switch the detector OFF and ensure fresh or fully charged batteries are inserted in to the detector.
2. Switch ON and if a fault alarm occurs switch OFF and conduct Factory Reset by pressing and holding the Power Button for five seconds.
3. If the fault alarm is removed conduct the Test Piece procedure to confirm correct operation of the MF5.
4. If the fault alarm continues switch OFF and return the detector to an Authorised Service Centre.

Safety Advice

The MF5 is safe to transport, store and operate when handled with the due care. Safety hazards applicable to this equipment are identified below.

Hazard	Precaution
Emission of non-ionising radiation.	The MD Sensor emits very low power magnetic fields and Radio Frequency (RF) energy. The radiated energy is significantly lower than that emitted by a mobile telephone and is safe to human health. Operators do not need to follow any specific safety precautions to mitigate hazards to human health posed by the emission of non-ionising radiation from the equipment.
Electromagnetic interference	While interference with communications equipment is unlikely, consideration should be given to potential effects on other equipment in proximity.
Internal voltages	Voltages potentially capable of causing electric shock are present on some internal conductors. Inspect the MF5 shafts, Coil, Control Box enclosure, and Batteries for evidence of damaged or exposed cables or electrical conductors prior to use. Do not use the equipment if there is any evidence of damaged or exposed cables or electrical conductors.
Speaker/Earset audio volume	Exposure to excessively high audio volumes with any audio generating equipment can cause discomfort and possible temporary and permanent hearing loss. The maximum output volume via the Earset and speaker for the detector are limited to be within safe levels for peak sound pressure level exposure. Operators should also use the Volume control to ensure the audio volume is not set above comfortable levels. Ensure the Volume control is not set above comfortable levels during operation.
Air transport safety requirements	The MF5 should not be powered On while being transported by air, and all applicable safety regulations must be followed in relation to carriage of electronic equipment. Batteries must be removed from the detector prior to air transport. The detector must be in its folded configuration when transporting by air. Follow all applicable safety regulations including the directions from aircrew when transporting MF5 equipment by air.
Ergonomic hazards	The MF5 is a lightweight detector, designed to minimise the risk of fatigue, strain, or other musculoskeletal injury to Operators. Operators using the equipment should always observe correct detecting posture and technique.

Hazard	Precaution
Exposed fibres from damaged carbon fibre shafts	<p>Inspect the detector shafts prior to use. Do not allow damaged or abraded carbon fibre shaft sections to come into contact with skin.</p> <p>The MF5 shafts are made from carbon fibre material. Damaged or abraded carbon fibre materials can expose fibres which can cause cuts and abrasions to skin, and ingress under the skin with potentially toxic effects.</p>
Pinch-points	<p>The MF5 has been designed to avoid the presence of pinch-points, but is a compact, collapsible piece of equipment that requires moderate care when extending or collapsing.</p> <p>Keep fingers clear of sliding and rotating mechanisms including shaft camlocks, and around the base of the folding handle when extending or collapsing the detector.</p>
Vibration-only detecting	<p>Do not rely on vibration feedback alone if wearing heavily padded gloves. This may result in the target being masked.</p>
Attempting shut-down whilst in Pinpoint mode	<p>Do not attempt to shut down the detector whilst in Pinpoint mode. This will result in activating Tactical mode.</p>
Battery precautions	<p>Do not expose cells or batteries to heat or fire. Avoid storage in direct sunlight. Do not dismantle, open or shred cells or batteries. Do not expose cells or batteries to mechanical shock or crushing.</p>

MF5 Detector Specification

General Specifications

Volume Control	1 to 9
Collapsed Size	400 × 99 × 194 mm (16 × 4 × 7.5 in)
Extended Size	1610 × 194 × 237 mm (63 × 7.5 × 9.5 in)
Weight, Operational	2.8 kg (6.2 lbs) with NiMH Rechargeable C cell batteries
Audio Adapter	Internal Speaker / Earset / Audio Adapter Cable
Earset	MF5 Earset
Waterproof	Waterproof to 3 m / 10 ft (IP 68)
Operating Temperature Range	-30°C to +60°C (-22°F to +140°F)
Storage Temperature Range	-30°C to +80°C (-22°F to +176°F)
Standards	MIL-STD-810G
EMC	MIL-STD-461G
Compliance	CE / RCM / FCC / IC
IP Rating	IP68
Software Upgradeable	Yes
Battery Compatibility	NiMH Rechargeable C cells / Alkaline
Battery Life	10 hours with NiMH batteries

Detection Specifications

Key Technologies	Simultaneous Multi-Frequency Digital Metal Detection
Coil	Transmit Coil: 269 × 191 mm (10.6 × 7.5 in) Monoloop Receive Coil: Figure 8
Operating Frequencies	4 frequencies in the range 5 kHz to 75 kHz
Output Power	< -30 dBm
Sensitivity	1 to 5
Noise Cancel	Automatic, Operator initiated
Ground Balance	Automatic, Operator initiated (<i>Settings retained after switch-off</i>)
Target Identification	Ferrous / Non-Ferrous / Carbon Rods and Fine Wires

Regulatory Information

Federal Communications Commission (FCC) Statement:

This device complies with part 18 of the FCC Rules.

Compliance Statement for Canada

This product meets the applicable Innovation, Science and Economic Development Canada technical specifications.

Le present produit est conforme aux specifications techniques retenues par l'Innovation, Sciences et Developpement economique Canada (ISDE).

Simplified EU Declaration of Conformity

Hereby, Minelab Electronics Pty Ltd declares that the radio equipment type MF5 complies with Directive 2014/53/EU. The full text of the EU declaration of conformity is available at the following internet address: www.minelab.com/compliance.

Modification

Any changes or modifications not expressly approved by the grantee of this device could void the user's authority to operate the device.

Toute modification non approuvee explicitement par le fournisseur de licence de l'appareil peut entrainer l'annulation du droit de l'utilisateur a utiliser l'appareil.

